

INDUSTRY

RESEARCH  
LABORATORY  
EDUCATION

DISTRIBUTION  
LOGISTICS

Robust.  
**Stable.**  
Versatile.



Cupboard and shelving systems.

KARL original.



# Steel cupboards from KARL: **Professional use** in assembly and production

## **Robust construction**

Steel cupboards and shelves from KARL stand out due to robust construction, first-class craftsmanship and clear, subtle design.



## **Functional unit**

In connection with KARL workplace systems they form a perfect functional unit, which harmonize with every modern, technical insert work environment and highest meeting quality requirements.



## **Flexible**

Assembly or packaging material, finished goods, files or tools - cupboard and shelf systems from KARL are versatile.



## **Variable**

Different door variants, variably relocatable shelves and storage systems for Euronorm containers or delivery boxes offer for every storage purpose an optimal solution.



### Quality

- robust construction made of first-class quality steel sheet
- high quality, resistant powder coating in light gray (RAL 7035)



### Lockable

- recessed security cylinder lock with 2 keys



### Height adjustable

- shelves and hanging brackets adjustable in height



### ESD-compliant construction

- standard-compliant according to IEC 61340-5-1
- all metal parts conductive powder coated



# The roll container and wooden cabinet range.

## First class storage.

### Robust construction

Cupboards and mobile containers from KARL combine a robust construction with a fine appearance.



### Individual office design

The first-class craftsmanship processed systems made of wood so equally for offices as well as for technical work areas.



### Arbitrarily expandable

Whether freestanding single cupboard or individually tailored wall unit - for every storage purpose and for everyone. The large variety of types offers space with different door variants and variably relocatable shelves a solution that leaves nothing to be desired.



### Timeless design

Light, light gray material and the clear, reserved form fit together harmoniously into the work environment and form in connection with KARL workplace systems an optical and functional unit.



### Robust surfaces

Light gray, melamine resin body coated fine chipboard (19 mm). Surface insensitive to scratches, abrasion resistant and easy to clean.



## High stability

- high transverse stability due to compact design
- body completely pegged and glued
- all edges with ABS edging (2 mm)
- stable, recessed rear panel (13 mm)
- Wing doors with 270° opening hinges



## Flexible height distribution

- Side walls with hole line in 32 mm grid
- Shelf support made of metal



## Lockable

- Lockable espagnolette lock with rotary olive



## Compensable

- Base with concealed metal height adjusters to compensate for uneven floors



## ESD compliant construction

- optionally also in ESD version
- standard-compliant according to IEC 61340-5-1



Functional.  
**Universal.**  
Combinable.



# Cupboard and shelving systems.

KARL original.

Content	Page	Content	Page
<b>Steel product range</b> .....	<b>8</b>	<b>Top cupboards</b> .....	<b>22</b>
Cupboards with double doors .....	8	Top cupboards with hinged doors .....	22
Cupboards with swing-in doors .....	8	Top cupboards with double doors with glass panels ..	23
Shelves .....	9	Top shelf .....	23
Delivery boxes .....	9	Top cupboards with sliding doors .....	24
Shelving system for Euronorm containers .....	10	Top cupboards with roller shutters .....	24
Euronorm container .....	10	<b>Corner cupboards</b> .....	<b>25</b>
<b>Rollcontainer</b> .....	<b>11</b>	<b>Equipment</b> .....	<b>27</b>
ESD insert tray for small parts .....	12	Wardrobe rail .....	27
ESD small parts boxes with transport tray .....	12	Installation frame for hanging files .....	27
Variable cross and longitudinal divisions .....	12	Intermediate plate with pull-out shelf .....	27
<b>Wood product range</b> .....	<b>13</b>	Ladder system .....	28
<b>Tall cupboards</b> .....	<b>13</b>	<b>Rollcontainer</b> .....	<b>29</b>
Tall cupboards with double doors .....	13	<b>The KARL product range</b> .....	<b>30</b>
Tall cupboards with double doors with glass panels ...	14		
<b>Shelves</b> .....	<b>15</b>		
<b>Side cupboards</b> .....	<b>16</b>		
Side cupboards with double doors .....	16		
Side cupboards with sliding doors .....	17		
Side cupboards with cross shutters .....	17		
Side cupboards with drawers .....	18		
Drawer organization .....	20		
Side cupboards for hanging files .....	21		

# Steel product range



## Cupboards with double doors

- height adjustable shelves in 60 mm increments
- max. load / shelf: 80 kg

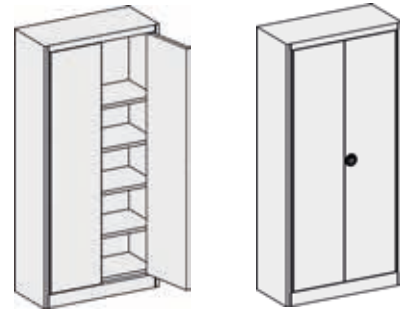

External dimensions

920 x 420 x 1950 mm (W x D x H)	incl. 4 shelves	<b>71.421.70</b>
920 x 650 x 1950 mm (W x D x H)	incl. 4 shelves	<b>71.461.70</b>

### Additional shelf

914 x 370 mm (W x D)	<b>76.021.70</b>
914 x 600 mm (W x D)	<b>76.061.70</b>

## Cupboards with swing-in doors

- doors swing into the cupboard body when opened
- height adjustable shelves in 60 mm increments
- max. load / shelf: 80 kg

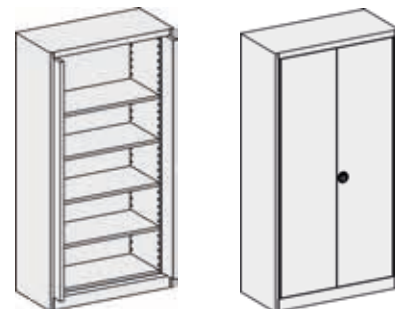

External dimensions

1100 x 530 x 2125 mm (W x D x H)	incl. 5 shelves	<b>72.641.70</b>
----------------------------------	-----------------	------------------

### Additional shelf

930 x 440 mm (W x D)	<b>76.041.70</b>
----------------------	------------------



## Shelves

- as a free-standing single shelf, row system or in block form (back to back)
- shelves made of galvanized sheet steel, height-adjustable in 50 mm increments with hanging brackets
- including bottom, lid and shelves
- delivery fully assembled
- max. load / shelf: 100 kg

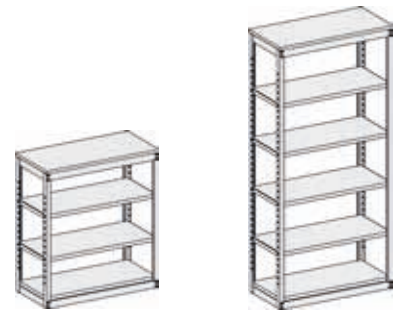

Height	Width x Depth		Cover:	Sheet steel	ESD laminate
1125 mm	975 x 455 mm	incl. 2 shelves		<b>60.424.43</b>	<b>60.424.34</b>
1125 mm	975 x 700 mm	incl. 2 shelves		<b>60.444.43</b>	<b>60.444.34</b>
Height	Width x Depth		Cover:	Sheet steel	ESD laminate
2125 mm	975 x 455 mm	incl. 4 shelves		<b>60.426.43</b>	<b>60.426.34</b>
2125 mm	975 x 700 mm	incl. 4 shelves		<b>60.446.43</b>	<b>60.446.34</b>

## Additional shelf

- made of galvanized sheet steel, incl. hanging bracket

for shelves

975 x 455 mm (W x D)	<b>60.922.43</b>
975 x 700 mm (W x D)	<b>60.944.43</b>

## Delivery boxes

- made of galvanized sheet steel
- with label holder
- strong stacking edges for safe stacking
- optimal shape due to ribbing
- optionally with recessed grip
- minimum purchase required - on request

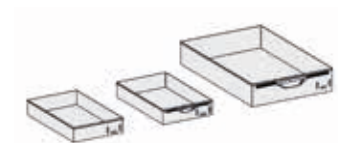

Type	Width	Depth	Height	Recessed grip	
B75	275 mm	450 mm	75 mm	no	<b>62.901.96</b>
B75	275 mm	450 mm	75 mm	yes	<b>62.902.96</b>
B115	452 mm	696 mm	115 mm	yes	<b>62.903.96</b>

## Shelving system for Euro standard containers

- guidance of the Euronorm containers on galvanized suspension brackets, height adjustable in 50 mm increments

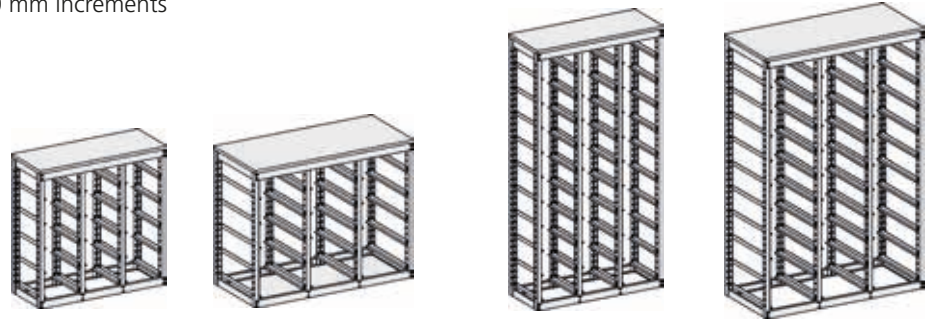

Height	Width x Depth	for Euronorm containers	Cover:	Sheet steel	ESD laminate
1125 mm	1120 x 425 mm	300 x 400 mm		<b>66.424.43</b>	<b>66.424.34</b>
1125 mm	1400 x 625 mm	300 x 400 mm, 600 x 400 mm		<b>66.644.43</b>	<b>66.644.34</b>

Height	Width x Depth		Cover:	Sheet steel	ESD laminate
2125 mm	1120 x 425 mm	300 x 400 mm		<b>66.426.43</b>	<b>66.426.34</b>
2125 mm	1400 x 625 mm	300 x 400mm, 600 x 400 mm		<b>66.646.43</b>	<b>66.646.34</b>

## Mounting bracket

- galvanized surface
- with push-through protection

	Depth:	400 mm	600 mm
1 set Mounting bracket		<b>66.901.96</b>	<b>66.902.96</b>

## Euronorm container

- optionally made of non-conductive low-pressure polyethylene (red) or ESD-compliant made of conductive polypropylene (black)

Height	Width x Depth	Standard	ESD
120 mm	300 x 400 mm	<b>96.540.98</b>	<b>96.550.98</b>
170 mm	300 x 400 mm	<b>96.542.98</b>	<b>96.552.98</b>
220 mm	300 x 400 mm	<b>96.544.98</b>	<b>96.554.98</b>

120 mm	600 x 400 mm	<b>96.560.98</b>	<b>96.570.98</b>
180 mm	600 x 400 mm	<b>96.562.98</b>	<b>96.572.98</b>
220 mm	600 x 400 mm	<b>96.564.98</b>	<b>96.574.98</b>
320 mm	600 x 400 mm	<b>96.566.98</b>	<b>96.576.98</b>

# Rollcontainer



- robust sheet steel case with central locking
- 1 cupboard height, 2 widths
- variable drawer divisions (1 HU = 54 mm)
- clear internal dimensions: W = 330 mm respectively 520 mm, D = 450 mm
- 4/5-extensible, drawer runners with steel ball bearings
- load capacity / drawer: 30 kg
- ESD-compliant due to conductive powder coating and conductive guides, connection of all parts with contact washers
- pull-out protection: only one drawer can be opened at a time

Optional:

- full extension drawers, drawer runners with telescopic rails  
load capacity / drawer: 45 kg

## Mobile drawer block F0

- 4 conductive castors (Ø 52 mm)
- 2 of them lockable
- H = 670 mm
- D = 540 mm



Drawer division	9 x 1 HU	2 x 1 HU 2 x 2 HU 1 x 3 HU	1 x 1 HU 4 x 2 HU	1 x 1 HU 1 x 2 HU 1 x 6 HU	3 x 3 HU
<b>Hard laminate cover</b>					
W = 418 mm	32.305.63	32.310.63	32.315.63	32.320.63	32.325.63
W = 606 mm	33.305.63	33.310.63	33.315.63	33.320.63	33.325.63
<b>Cover directly coated, ESD</b>					
W = 418 mm	32.305.34	32.310.34	32.315.34	32.320.34	32.325.34
W = 606 mm	33.305.34	33.310.34	33.315.34	33.320.34	33.325.34
<b>Cover ESD hard laminate</b>					
W = 418 mm	32.305.66	32.310.66	32.315.66	32.320.66	32.325.66
W = 606 mm	33.305.66	33.310.66	33.315.66	33.320.66	33.325.66

## ESD insert tray for small parts

- made of conductive plastic
- 2 trays can be used per drawer
- H = 31 mm

insert tray with 7 compartments for W = 418 mm	<b>96.205.98</b>
insert tray with 11 compartments for W = 606 mm	<b>96.206.98</b>

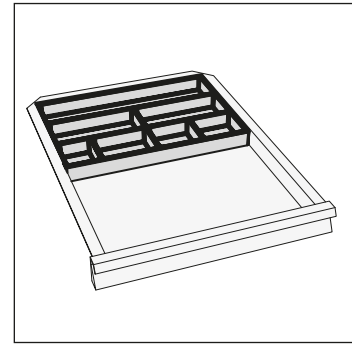

## ESD small parts boxes with transport tray

- made of conductive plastic
- insert tray with removable small parts boxes
- 2 trays can be used per drawer (W = 418 mm)
- H = 42 mm

set of 4 small parts boxes 54 x 108 mm and 108 x 108 mm	<b>96.216.98</b>
---------------------------------------------------------	------------------

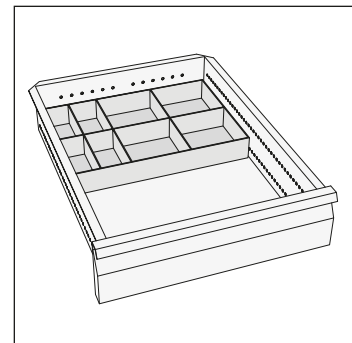

## Variable cross and longitudinal divisions

- adjustable in grid
- made of powder-coated sheet steel
- H = 73 mm

Cross dividers, W = 330 mm	<b>96.225.98</b>
Cross dividers, W = 330 mm	<b>96.226.98</b>
Longitudinal divisions, 303 mm / A4 landscape	<b>96.227.98</b>
Longitudinal divisions, 213 mm / A5 landscape	<b>96.229.98</b>
Longitudinal divisions, 113 mm / A6 landscape	<b>96.231.98</b>



# Wood product range



## Tall cupboards

- Height 2064 mm
- 5 Folder heights
- incl. 4 height-adjustable shelves

### Tall cupboard with double doors

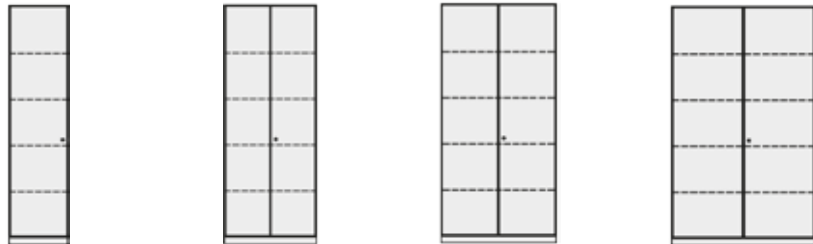

Width x Height		500 x 2064 mm	800 x 2064 mm	1000 x 2064 mm	1200 x 2064 mm
Depth 450 mm	Standard	<b>505.451.00</b>	<b>508.451.00</b>	<b>510.451.00</b>	<b>512.451.00</b>
	ESD	<b>505.451.01</b>	<b>508.451.01</b>	<b>510.451.01</b>	<b>512.451.01</b>
Depth 650 mm	Standard	<b>505.651.00</b>	<b>508.651.00</b>	<b>510.651.00</b>	<b>512.651.00</b>
	ESD	<b>505.651.01</b>	<b>508.651.01</b>	<b>510.651.01</b>	<b>512.651.01</b>

### Additional shelf

- Thickness 28 mm

Width		460 mm	760 mm	960 mm	1160 mm
Depth 400 mm	Standard	<b>705.411.10</b>	<b>708.411.10</b>	<b>710.411.10</b>	<b>712.411.10</b>
	ESD	<b>705.411.11</b>	<b>708.411.11</b>	<b>710.411.11</b>	<b>712.411.11</b>
Depth 600 mm	Standard	<b>705.611.10</b>	<b>708.611.10</b>	<b>710.611.10</b>	<b>712.611.10</b>
	ESD	<b>705.611.11</b>	<b>708.611.11</b>	<b>710.611.11</b>	<b>712.611.11</b>

## Tall cupboard with hinged doors with glass panels

- doors with inserted safety glass, 4 mm thick

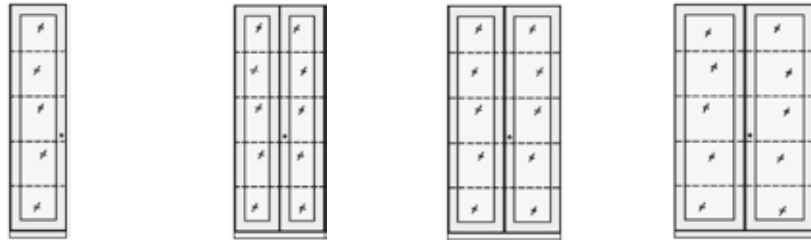

Width x Height		500 x 2064 mm	800 x 2064 mm	1000 x 2064 mm	1200 x 2064 mm
Depth 450 mm	Standard	<b>505.452.00</b>	<b>508.452.00</b>	<b>510.452.00</b>	<b>512.452.00</b>
	ESD	<b>505.452.01</b>	<b>508.452.01</b>	<b>510.452.01</b>	<b>512.452.01</b>
Depth 650 mm	Standard	<b>505.652.00</b>	<b>508.652.00</b>	<b>510.652.00</b>	<b>512.652.00</b>
	ESD	<b>505.652.01</b>	<b>508.652.01</b>	<b>510.652.01</b>	<b>512.652.01</b>

## Side cupboard with hinged doors with glass panels

- Height: 1352 mm, 3 folder heights
- with inserted safety glass, 4 mm thick
- incl. 2 adjustable shelves

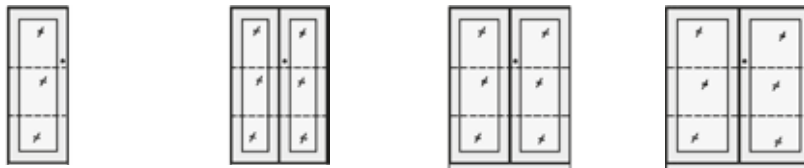

Width x Height		500 x 1352 mm	800 x 1352 mm	1000 x 1352 mm	1200 x 1352 mm
Depth 450 mm	Standard	<b>505.432.00</b>	<b>508.432.00</b>	<b>510.432.00</b>	<b>512.432.00</b>
	ESD	<b>505.432.01</b>	<b>508.432.01</b>	<b>510.432.01</b>	<b>512.432.01</b>
Depth 650 mm	Standard	<b>505.632.00</b>	<b>508.632.00</b>	<b>510.632.00</b>	<b>512.632.00</b>
	ESD	<b>505.632.01</b>	<b>508.632.01</b>	<b>510.632.01</b>	<b>512.632.01</b>

## Additional shelf

- Thickness 28 mm

Width		460 mm	760 mm	960 mm	1160 mm
Depth 400 mm	Standard	<b>705.411.10</b>	<b>708.411.10</b>	<b>710.411.10</b>	<b>712.411.10</b>
	ESD	<b>705.411.11</b>	<b>708.411.11</b>	<b>710.411.11</b>	<b>712.411.11</b>
Depth 600 mm	Standard	<b>705.611.10</b>	<b>708.611.10</b>	<b>710.611.10</b>	<b>712.611.10</b>
	ESD	<b>705.611.11</b>	<b>708.611.11</b>	<b>710.611.11</b>	<b>712.611.11</b>

# Shelves

- Height 2064 mm, 5 folder heights
- incl. 4 height-adjustable shelves



Width x Height		500 x 2064 mm	800 x 2064 mm	1000 x 2064 mm	1200 x 2064 mm
Depth 430 mm	Standard	<b>505.455.00</b>	<b>508.455.00</b>	<b>510.455.00</b>	<b>512.455.00</b>
	ESD	<b>505.455.01</b>	<b>508.455.01</b>	<b>510.455.01</b>	<b>512.455.01</b>
Depth 630 mm	Standard	<b>505.655.00</b>	<b>508.655.00</b>	<b>510.655.00</b>	<b>512.655.00</b>
	ESD	<b>505.655.01</b>	<b>508.655.01</b>	<b>510.655.01</b>	<b>512.655.01</b>

- Height 1352 mm, 3 folder heights
- incl. 2 height-adjustable shelves

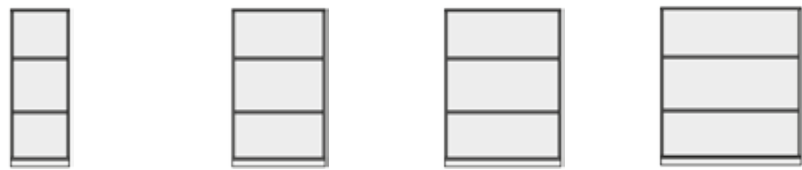

Width x Height		500 x 1352 mm	800 x 1352 mm	1000 x 1352 mm	1200 x 1352 mm
Depth 430 mm	Standard	<b>505.435.00</b>	<b>508.435.00</b>	<b>510.435.00</b>	<b>512.435.00</b>
	ESD	<b>505.435.01</b>	<b>508.435.01</b>	<b>510.435.01</b>	<b>512.435.01</b>
Depth 630 mm	Standard	<b>505.635.00</b>	<b>508.635.00</b>	<b>510.635.00</b>	<b>512.635.00</b>
	ESD	<b>505.635.01</b>	<b>508.635.01</b>	<b>510.635.01</b>	<b>512.635.01</b>

- Height 772 mm, 2 folder heights
- including 1 height-adjustable shelf



Width x Height		500 x 772 mm	800 x 772 mm	1000 x 772 mm	1200 x 772 mm
Depth 430 mm	Standard	<b>505.425.00</b>	<b>508.425.00</b>	<b>510.425.00</b>	<b>512.425.00</b>
	ESD	<b>505.425.01</b>	<b>508.425.01</b>	<b>510.425.01</b>	<b>512.425.01</b>
Depth 630 mm	Standard	<b>505.625.00</b>	<b>508.625.00</b>	<b>510.625.00</b>	<b>512.625.00</b>
	ESD	<b>505.625.01</b>	<b>508.625.01</b>	<b>510.625.01</b>	<b>512.625.01</b>

## Additional shelf

- Thickness 28 mm

Width		460 mm	760 mm	960 mm	1160 mm
Depth 400 mm	Standard	<b>705.411.10</b>	<b>708.411.10</b>	<b>710.411.10</b>	<b>712.411.10</b>
	ESD	<b>705.411.11</b>	<b>708.411.11</b>	<b>710.411.11</b>	<b>712.411.11</b>
Depth 600 mm	Standard	<b>705.611.10</b>	<b>708.611.10</b>	<b>710.611.10</b>	<b>712.611.10</b>
	ESD	<b>705.611.11</b>	<b>708.611.11</b>	<b>710.611.11</b>	<b>712.611.11</b>

# Side cupboards



## Side cupboard with double doors

- Height 1352 mm, 3 folder heights
- incl. 2 adjustable shelves



Width x Height		500 x 1352 mm	800 x 1352 mm	1000 x 1352 mm	1200 x 1352 mm
Depth 450 mm	Standard	<b>505.431.00</b>	<b>508.431.00</b>	<b>510.431.00</b>	<b>512.431.00</b>
	ESD	<b>505.431.01</b>	<b>508.431.01</b>	<b>510.431.01</b>	<b>512.431.01</b>
Depth 650 mm	Standard	<b>505.631.00</b>	<b>508.631.00</b>	<b>510.631.00</b>	<b>512.631.00</b>
	ESD	<b>505.631.01</b>	<b>508.631.01</b>	<b>510.631.01</b>	<b>512.631.01</b>

- Height 772 mm, 2 folder heights
- incl. 1 adjustable shelf



Width x Height		500 x 772 mm	800 x 772 mm	1000 x 772 mm	1200 x 772 mm
Depth 450 mm	Standard	<b>505.421.00</b>	<b>508.421.00</b>	<b>510.421.00</b>	<b>512.421.00</b>
	ESD	<b>505.421.01</b>	<b>508.421.01</b>	<b>510.421.01</b>	<b>512.421.01</b>
Depth 650 mm	Standard	<b>505.621.00</b>	<b>508.621.00</b>	<b>510.621.00</b>	<b>512.621.00</b>
	ESD	<b>505.621.01</b>	<b>508.621.01</b>	<b>510.621.01</b>	<b>512.621.01</b>

## Additional shelf

- Thickness 28 mm

Width		460 mm	760 mm	960 mm	1160 mm
Depth 400 mm	Standard	<b>705.411.10</b>	<b>708.411.10</b>	<b>710.411.10</b>	<b>712.411.10</b>
	ESD	<b>705.411.11</b>	<b>708.411.11</b>	<b>710.411.11</b>	<b>712.411.11</b>
Depth 600 mm	Standard	<b>705.611.10</b>	<b>708.611.10</b>	<b>710.611.10</b>	<b>712.611.10</b>
	ESD	<b>705.611.11</b>	<b>708.611.11</b>	<b>710.611.11</b>	<b>712.611.11</b>



## Side cupboard with sliding doors

- 3 folder heights: including center partition and 2 x 2 adjustable shelves
- 2 folder heights: including center partition and 1 x 2 adjustable shelves
- locking system lock
- matt nickel-plated segment handles (further handle variants optional)



Width x Height		1200 x 1352 mm	1200 x 772 mm
Depth 450 mm	Standard	<b>512.433.00</b>	<b>512.423.00</b>
	ESD	<b>512.433.01</b>	<b>512.423.01</b>
Depth 650 mm	Standard	<b>512.633.00</b>	<b>512.623.00</b>
	ESD	<b>512.633.01</b>	<b>512.623.01</b>

### Additional shelf

- Thickness 28 mm

Depth		Width	
Depth 390 mm	Standard	570 mm	<b>712.412.20</b>
	ESD	570 mm	<b>712.412.21</b>
Depth 590 mm	Standard	570 mm	<b>712.612.20</b>
	ESD	570 mm	<b>712.612.21</b>

## Side cupboard with cross shutters

- 3 folder heights: incl. 2 adjustable shelves
- 2 folder heights: incl. 1 adjustable shelf
- cross shutters open from right to left (clear width = 1000 mm)
- locking system lock
- matt nickel-plated segment handle (further handle variants optional)



Width x Height		1200 x 1352 mm	1200 x 772 mm
Depth 450 mm	Standard	<b>512.434.00</b>	<b>512.424.00</b>
	Standard	<b>512.634.00</b>	<b>512.624.00</b>

### Additional shelf

- Thickness 28 mm

For cupboard depth

450 mm	Standard	960 x 390 mm (W x D)	<b>712.413.10</b>
650 mm	Standard	960 x 590 mm (W x D)	<b>712.613.10</b>

## Side cupboards with drawers

- organizable steel drawer troughs with full telescopic extension, black powder-coated
- upper drawer with central locking
- matt nickel-plated segment handles (further handle variants optional)
- front panel height: 1 HU = 32 mm
- internal drawer dimensions: see page 20



### Width x Height: 800 x 1352 mm



		4 Drawers	5 Drawers	7 Drawers	9 Drawers
Aperture heights (HU)		7/11/11/11	7/8/8/8/9	7/4/4/4/6/6/9	7/4/4/4/4/4/4/5
Depth 450 mm	Standard	<b>508.436.10</b>	<b>508.436.20</b>	<b>508.436.30</b>	<b>508.436.40</b>
	ESD	<b>508.436.11</b>	<b>508.436.21</b>	<b>508.436.31</b>	<b>508.436.41</b>
Depth 650 mm	Standard	<b>508.636.10</b>	<b>508.636.20</b>	<b>508.636.30</b>	<b>508.636.40</b>
	EDS	<b>508.636.11</b>	<b>508.636.21</b>	<b>508.636.31</b>	<b>508.636.41</b>

### Width x Height: 800 x 772 mm



		2 Drawers	3 Drawers	4 Drawers	4 Drawers
Aperture heights (HU)		11/11	7/7/8	7/4/4/7	7/5/5/5
Depth 450 mm	Standard	<b>508.426.10</b>	<b>508.426.20</b>	<b>508.426.30</b>	<b>508.426.40</b>
	ESD	<b>508.426.11</b>	<b>508.426.21</b>	<b>508.426.31</b>	<b>508.426.41</b>
Depth 650 mm	Standard	<b>508.626.10</b>	<b>508.626.20</b>	<b>508.626.30</b>	<b>508.626.40</b>
	EDS	<b>508.626.11</b>	<b>508.626.21</b>	<b>508.626.31</b>	<b>508.626.41</b>

**Width x Height: 1000 x 1352 mm**



		4 Drawers	5 Drawers	7 Drawers	9 Drawers
Aperture heights (HU)		7/11/11/11	7/8/8/8/9	7/4/4/4/6/6/9	7/4/4/4/4/4/4/5
Depth 450 mm	Standard	<b>510.436.10</b>	<b>510.436.20</b>	<b>510.436.30</b>	<b>510.436.40</b>
	ESD	<b>510.436.11</b>	<b>510.436.21</b>	<b>510.436.31</b>	<b>510.436.41</b>
Depth 650 mm	Standard	<b>510.636.10</b>	<b>510.636.20</b>	<b>510.636.30</b>	<b>510.636.40</b>
	EDS	<b>510.636.11</b>	<b>510.636.21</b>	<b>510.636.31</b>	<b>510.636.41</b>

**Width x Height: 1000 x 772 mm**



		2 Drawers	3 Drawers	4 Drawers	4 Drawers
Aperture heights (HU)		11/11	7/7/8	7/4/4/7	7/5/5/5
Depth 450 mm	Standard	<b>510.426.10</b>	<b>510.426.20</b>	<b>510.426.30</b>	<b>510.426.40</b>
	ESD	<b>510.426.11</b>	<b>510.426.21</b>	<b>510.426.31</b>	<b>510.426.41</b>
Depth 650 mm	Standard	<b>510.626.10</b>	<b>510.626.20</b>	<b>510.626.30</b>	<b>510.626.40</b>
	EDS	<b>510.626.11</b>	<b>510.626.21</b>	<b>510.626.31</b>	<b>510.626.41</b>

**Width x Height: 1200 x 1352 mm**



		4 Drawers	5 Drawers	7 Drawers	9 Drawers
Aperture heights (HU)		7/11/11/11	7/8/8/8/9	7/4/4/4/6/6/9	7/4/4/4/4/4/4/5
Depth 450 mm	Standard	<b>512.436.10</b>	<b>512.436.20</b>	<b>512.436.30</b>	<b>512.436.40</b>
	ESD	<b>512.436.11</b>	<b>512.436.21</b>	<b>512.436.31</b>	<b>512.436.41</b>
Depth 650 mm	Standard	<b>512.636.10</b>	<b>512.636.20</b>	<b>512.636.30</b>	<b>512.636.40</b>
	EDS	<b>512.636.11</b>	<b>512.636.21</b>	<b>512.636.31</b>	<b>512.636.41</b>

**Width x Height: 1200 x 772 mm**



		2 Drawers	3 Drawers	4 Drawers	4 Drawers
Aperture heights (HU)		11/11	7/7/8	7/4/4/7	7/5/5/5
Depth 450 mm	Standard	<b>512.426.10</b>	<b>512.426.20</b>	<b>512.426.30</b>	<b>512.426.40</b>
	ESD	<b>512.426.11</b>	<b>512.426.21</b>	<b>512.426.31</b>	<b>512.426.41</b>
Depth 650 mm	Standard	<b>512.626.10</b>	<b>512.626.20</b>	<b>512.626.30</b>	<b>512.626.40</b>
	EDS	<b>512.626.11</b>	<b>512.626.21</b>	<b>512.626.31</b>	<b>512.626.41</b>

# Drawer organization

Inner drawer dimensions

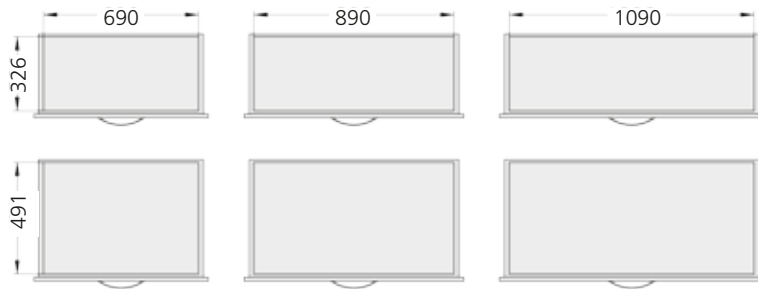

## Orgaline for front and back

- steel, black powder-coated



for cupboard width	800 mm	1000 mm	1200 mm
	<b>708.071.00</b>	<b>710.071.00</b>	<b>712.071.00</b>

## Partition walls as longitudinal division

- with side latches
- for locking in the Orgaline
- steel, black powder-coated



for cupboard depth		450 mm	650 mm
		<b>700.481.00</b>	<b>700.681.00</b>

## Compartment divider as cross division

- for locking between partition walls
- steel, black powder-coated

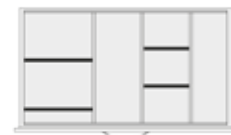

Shelf divider for format	A4	A5	A6	A7
	<b>700.084.00</b>	<b>700.085.00</b>	<b>700.086.00</b>	<b>700.087.00</b>

## Side cupboards for hanging files

- upper drawer with central locking
- matt nickel-plated segment bow handles (other handle variants optional)
- front panel height = 350 mm
- including frame for A4 hanging bags

### 3 Drawers



Width x Height		800 x 1352 mm	1000 x 1352 mm	1200 x 1352 mm
Depth 450 mm	Standard	<b>508.437.00</b>	<b>510.437.00</b>	<b>512.437.00</b>
	ESD	<b>508.437.01</b>	<b>510.437.01</b>	<b>512.437.01</b>
Depth 650 mm	Standard	<b>508.637.00</b>	<b>510.637.00</b>	<b>512.637.00</b>
	ESD	<b>508.637.01</b>	<b>510.637.01</b>	<b>512.637.01</b>

### 2 Drawers



Width x Height		800 x 772 mm	1000 x 772 mm	1200 x 772 mm
Depth 450 mm	Standard	<b>508.427.00</b>	<b>510.427.00</b>	<b>512.427.00</b>
	ESD	<b>508.427.01</b>	<b>510.427.01</b>	<b>512.427.01</b>
Depth 650 mm	Standard	<b>508.627.00</b>	<b>510.627.00</b>	<b>512.627.00</b>
	ESD	<b>508.627.01</b>	<b>510.627.01</b>	<b>512.627.01</b>

# Top cupboards



## Top cupboard with hinged doors

- Height 1292 mm, 3 folder heights
- incl. 2 height adjustable shelves

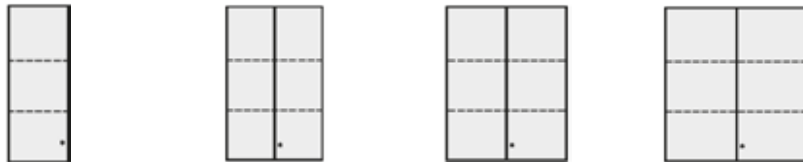

Width x Height		500 x 1292 mm	800 x 1292 mm	1000 x 1292 mm	1200 x 1292 mm
Depth 450 mm	Standard	<b>605.431.00</b>	<b>608.431.00</b>	<b>610.431.00</b>	<b>612.431.00</b>
	ESD	<b>605.431.01</b>	<b>608.431.01</b>	<b>610.431.01</b>	<b>612.431.01</b>
Depth 650 mm	Standard	<b>605.631.00</b>	<b>608.631.00</b>	<b>610.631.00</b>	<b>612.631.00</b>
	ESD	<b>605.631.01</b>	<b>608.631.01</b>	<b>610.631.01</b>	<b>612.631.01</b>

- Height 712 mm, 2 folder heights
- incl. height-adjustable shelf



Width x Height		500 x 712 mm	800 x 712 mm	1000 x 712 mm	1200 x 712 mm
Depth 450 mm	Standard	<b>605.421.00</b>	<b>608.421.00</b>	<b>610.421.00</b>	<b>612.421.00</b>
	ESD	<b>605.421.01</b>	<b>608.421.01</b>	<b>610.421.01</b>	<b>612.421.01</b>
Depth 650 mm	Standard	<b>605.621.00</b>	<b>608.621.00</b>	<b>610.621.00</b>	<b>612.621.00</b>
	ESD	<b>605.621.01</b>	<b>608.621.01</b>	<b>610.621.01</b>	<b>612.621.01</b>

## Additional shelf

- Thickness 28 mm

Width		460 mm	760 mm	960 mm	1160 mm
Depth 400 mm	Standard	<b>705.411.10</b>	<b>708.411.10</b>	<b>710.411.10</b>	<b>712.411.10</b>
	ESD	<b>705.411.11</b>	<b>708.411.11</b>	<b>710.411.11</b>	<b>712.411.11</b>
Depth 600 mm	Standard	<b>705.611.10</b>	<b>708.611.10</b>	<b>710.611.10</b>	<b>712.611.10</b>
	ESD	<b>705.611.11</b>	<b>708.611.11</b>	<b>710.611.11</b>	<b>712.611.11</b>

## Top cupboard with hinged doors with glass panels

- Height: 1292 mm, 3 folder heights
- incl. 2 height adjustable shelves

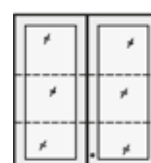
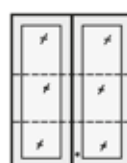

Width x Height		500 x 1292 mm	800 x 1292 mm	1000 x 1292 mm	1200 x 1292 mm
Depth 450 mm	Standard	<b>605.432.00</b>	<b>608.432.00</b>	<b>610.432.00</b>	<b>612.432.00</b>
	ESD	<b>605.432.01</b>	<b>608.432.01</b>	<b>610.432.01</b>	<b>612.432.01</b>
Depth 650 mm	Standard	<b>605.632.00</b>	<b>608.632.00</b>	<b>610.632.00</b>	<b>612.632.00</b>
	ESD	<b>605.632.01</b>	<b>608.632.01</b>	<b>610.632.01</b>	<b>612.632.01</b>

## Top shelf

- Height: 1292 mm, 3 folder heights
- incl. 2 height adjustable shelves



Width x Height		500 x 1292 mm	800 x 1292 mm	1000 x 1292 mm	1200 x 1292 mm
Depth 430 mm	Standard	<b>605.435.00</b>	<b>608.435.00</b>	<b>610.435.00</b>	<b>612.435.00</b>
	ESD	<b>605.435.01</b>	<b>608.435.01</b>	<b>610.435.01</b>	<b>612.435.01</b>
Depth 630 mm	Standard	<b>605.635.00</b>	<b>608.635.00</b>	<b>610.635.00</b>	<b>612.635.00</b>
	ESD	<b>605.635.01</b>	<b>608.635.01</b>	<b>610.635.01</b>	<b>612.635.01</b>

- Height: 712 mm, 2 folder heights
- incl. height-adjustable shelf



Width x Height		500 x 712 mm	800 x 712 mm	1000 x 712 mm	1200 x 712 mm
Depth 430 mm	Standard	<b>605.425.00</b>	<b>608.425.00</b>	<b>610.425.00</b>	<b>612.425.00</b>
	ESD	<b>605.425.01</b>	<b>608.425.01</b>	<b>610.425.01</b>	<b>612.425.01</b>
Depth 630 mm	Standard	<b>605.625.00</b>	<b>608.625.00</b>	<b>610.625.00</b>	<b>612.625.00</b>
	ESD	<b>605.625.01</b>	<b>608.625.01</b>	<b>610.625.01</b>	<b>612.625.01</b>

## Additional shelf

- Thickness 28 mm

Width		460 mm	760 mm	960 mm	1160 mm
Depth 400 mm	Standard	<b>705.411.10</b>	<b>708.411.10</b>	<b>710.411.10</b>	<b>712.411.10</b>
	ESD	<b>705.411.11</b>	<b>708.411.11</b>	<b>710.411.11</b>	<b>712.411.11</b>
Depth 600 mm	Standard	<b>705.611.10</b>	<b>708.611.10</b>	<b>710.611.10</b>	<b>712.611.10</b>
	ESD	<b>705.611.11</b>	<b>708.611.11</b>	<b>710.611.11</b>	<b>712.611.11</b>

## Top cupboard with sliding doors

- 3 folder heights: incl. centre partition and 2 x 2 height-adjustable shelves
- 2 folder heights: incl. centre partition and 2 x 1 height-adjustable shelves
- locking system lock
- matt nickel-plated segment handles (other handle variants optional)



Width x Height		1200 x 1292 mm	1200 x 712 mm
Depth 450 mm	Standard	<b>612.433.00</b>	<b>612.423.00</b>
	ESD	<b>612.433.01</b>	<b>612.423.01</b>
Depth 650 mm	Standard	<b>612.633.00</b>	<b>612.623.00</b>
	ESD	<b>612.633.01</b>	<b>612.623.01</b>

### Additional shelf

- Thickness 28 mm
- For cupboard dept

450 mm	Standard	570 x 390 mm (W x D)	<b>712.412.20</b>
	ESD	570 x 390 mm (W x D)	<b>712.412.21</b>
650 mm	Standard	570 x 590 mm (W x D)	<b>712.612.20</b>
	ESD	570 x 590 mm (W x D)	<b>712.612.21</b>

## Top cupboard with cross roller shutter

- 3 folder heights: inkl. 2 höhenversetzbaren Fachböden
- 2 folder heights: inkl. höhenversetzbarem Fachboden
- Querrolladen von rechts nach links zu öffnen (lichte Breite = 1000 mm)
- locking system lock
- Matt nickel-plated segment handles (other handle variants optional)

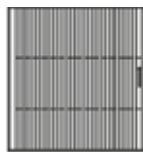

Width x Height		1200 x 1292 mm	1200 x 712 mm
Depth 450 mm	Standard	<b>612.434.00</b>	<b>612.424.00</b>
	ESD	<b>612.434.01</b>	<b>612.424.01</b>
Depth 650 mm	Standard	<b>612.634.00</b>	<b>612.624.00</b>
	ESD	<b>612.634.01</b>	<b>612.624.01</b>

### Additional shelf

- Thickness 28 mm
- For cupboard dept

450 mm	Standard	960 x 390 mm (W x D)	<b>712.413.10</b>
650 mm	Standard	960 x 590 mm (W x D)	<b>712.613.10</b>



# Corner cupboards

## For wall units with depth = 450 mm

- Width = 817 mm

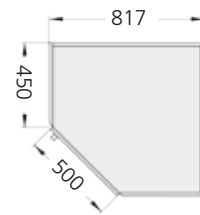

### Cupboard with hinged door

Height = 2064 mm (5 folder heights) inkl. 4 höhenversetzbaren Fachböden	Standard	<b>505.451.80</b>
	ESD	<b>505.451.81</b>
Height = 1352 mm (3 folder heights), inkl. 2 höhenversetzbaren Fachböden	Standard	<b>505.431.80</b>
	ESD	<b>505.431.81</b>
Height = 772 mm (2 folder heights), inkl. höhenversetzbarem Fachboden	Standard	<b>505.421.80</b>
	ESD	<b>505.421.81</b>

### Top cupboard with double door

Height = 1292 mm (3 folder heights), inkl. 2 höhenversetzbaren Fachböden	Standard	<b>605.431.80</b>
	ESD	<b>605.431.81</b>
Height = 712 mm (2 folder heights), inkl. höhenversetzbarem Fachboden	Standard	<b>605.421.80</b>
	ESD	<b>605.421.81</b>

### Shelf

Height = 2064 mm (5 folder heights) inkl. 4 höhenversetzbaren Fachböden	Standard	<b>505.455.80</b>
	ESD	<b>505.455.81</b>
Height = 1352 mm (3 folder heights), inkl. 2 höhenversetzbaren Fachböden	Standard	<b>505.435.80</b>
	ESD	<b>505.435.81</b>
Height = 772 mm (2 folder heights), inkl. höhenversetzbarem Fachboden	Standard	<b>505.425.80</b>
	ESD	<b>505.425.81</b>

### Top shelf

Height = 1292 mm (3 folder heights), inkl. 2 höhenversetzbaren Fachböden	Standard	<b>605.435.80</b>
	ESD	<b>605.435.81</b>
Height = 712 mm (2 folder heights), inkl. höhenversetzbarem Fachboden	Standard	<b>605.425.80</b>
	ESD	<b>605.425.81</b>

# Corner cupboards

For wall units with depth = 650 mm

- Width = 1017 mm

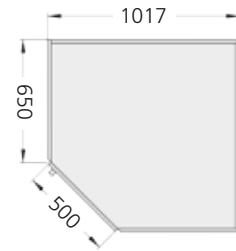

## Cupboard with hinged door

Height = 2064 mm (5 folder heights) inkl. 4 höhenversetzbaren Fachböden	Standard	<b>505.651.80</b>
	ESD	<b>505.651.81</b>
Height = 1352 mm (3 folder heights), inkl. 2 höhenversetzbaren Fachböden	Standard	<b>505.631.80</b>
	ESD	<b>505.631.81</b>
Height = 772 mm (2 folder heights), inkl. höhenversetzbarem Fachboden	Standard	<b>505.621.80</b>
	ESD	<b>505.621.81</b>

## Top cupboard with double door

Height = 1292 mm (3 folder heights), inkl. 2 höhenversetzbaren Fachböden	Standard	<b>605.631.80</b>
	ESD	<b>605.631.81</b>
Height = 712 mm (2 folder heights), inkl. höhenversetzbarem Fachboden	Standard	<b>605.621.80</b>
	ESD	<b>605.621.81</b>

## Shelf

Height = 2064 mm (5 folder heights) inkl. 4 höhenversetzbaren Fachböden	Standard	<b>505.655.80</b>
	ESD	<b>505.655.81</b>
Height = 1352 mm (3 folder heights), inkl. 2 höhenversetzbaren Fachböden	Standard	<b>505.635.80</b>
	ESD	<b>505.635.81</b>
Height = 772 mm (2 folder heights), inkl. höhenversetzbarem Fachboden	Standard	<b>505.625.80</b>
	ESD	<b>505.625.81</b>

## Top shelf

Height = 1292 mm (3 folder heights), inkl. 2 höhenversetzbaren Fachböden	Standard	<b>605.635.80</b>
	ESD	<b>605.635.81</b>
Height = 712 mm (2 folder heights), inkl. höhenversetzbarem Fachboden	Standard	<b>605.625.80</b>
	ESD	<b>605.625.81</b>

# Equipment

## Wardrobe rail

- for cupboards with depth = 650 mm
- mounted across the bottom of the shelf
- including shelf

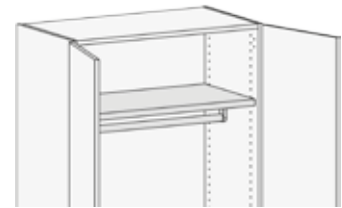

for cupboard width	500 mm	800 mm	1000 mm	1200 mm
	<b>705.631.00</b>	<b>708.631.00</b>	<b>710.631.00</b>	<b>712.631.00</b>

## Installation frame for hanging files

- made of powder-coated sheet steel (black)
- load capacity: 70 kg
- telescopic full extension, optionally with pull-out protection

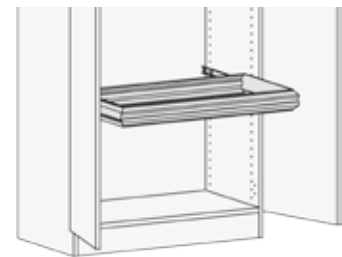

for cupboard width	500 mm	800 mm	1000 mm	1200 mm
Depth 450 mm	<b>705.421.00</b>	<b>708.421.00</b>	<b>710.421.00</b>	<b>712.421.00</b>
Depth 650 mm	<b>705.621.00</b>	<b>708.621.00</b>	<b>710.621.00</b>	<b>712.621.00</b>

## Intermediate plate with pull-out shelf

- pull-out shelf with matt nickel-plated segment handle (further handle variants optional)
- Height = 19 mm

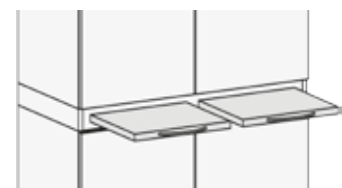

for cupboard width	500 mm	800 mm	1000 mm	1200 mm
Depth 450 mm	<b>705.441.00</b>	<b>708.441.00</b>	<b>710.441.00</b>	<b>712.441.00</b>
Depth 650 mm	<b>705.641.00</b>	<b>708.641.00</b>	<b>710.641.00</b>	<b>712.641.00</b>

## Ladder system

- conductor guide and metal brackets
- cover in cupboard design, height = 150 mm
- light metal ladder

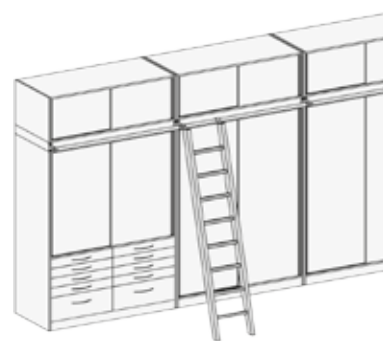

Leadership / running meters	<b>700.651.00</b>
Ladder with casters	<b>700.656.00</b>
Ladder with suspension bracket	<b>700.657.00</b>

# Rollcontainer

- body made of melamine resin coated fine chipboard, doweled and glued
- front panel height: 1 HU = 50 mm
- organizable steel thrust trays with 4/5 pull-out
- optionally with full extension
- 1 HU pull-out with plastic material tray
- 6 HU pull-out with frame for A4 wallets
- matt nickel-plated segment handles (further handle variants optional)
- 4 swivel castors, 2 of which can be locked
- central locking
- pull-out protection: only one drawer can be opened at a time
- stable mounting of the rollers on a metal plate
- optional ESD compliant



**Width x Height: 435 x 602 mm**



		5 Drawers 1/2/2/2/3	4 Drawers 1/3/3/3	4 Drawers 1/2/3/4	3 Drawers 1/3/6
Aperture heights (HU)					
Depth 600 mm	Standard	<b>360.100.00</b>	<b>360.200.00</b>	<b>360.300.00</b>	<b>360.400.00</b>
	ESD	<b>360.100.01</b>	<b>360.200.01</b>	<b>360.300.01</b>	<b>360.400.01</b>
Depth 800 mm	Standard	<b>380.100.00</b>	<b>380.200.00</b>	<b>380.300.00</b>	<b>380.400.00</b>
	ESD	<b>380.100.01</b>	<b>380.200.01</b>	<b>380.300.01</b>	<b>380.400.01</b>

## Compartment divider for drawer organization



divisible partition for cross division	<b>704.061.00</b>
A5 compartment divider for additional longitudinal division	<b>704.065.00</b>
A6 compartment divider for additional longitudinal division	<b>704.066.00</b>

# The **KARL-product range.**

Optimal solutions require a precise analysis of the work processes.  
KARL defines itself as a system supplier for modern, ergonomic workplace design.

The intensive cooperation and the qualified dialogue with our customers is the basis  
for a tailor-made solution for your task.

We also take production-specific requirements and spatial conditions  
like the individual needs of each employee into account.

We visualize functionality, ergonomics, handling and implementation of the spatial specifications  
in a three-dimensional layout.



## **QUADRO.**

The workplace system for the highest demands.

## **QUADRO twin.**

The classic table system with all options.



## **SINTRO.**

The variable assembly workstation.



## **SINTRO pack.**

The solution for packing stations.



**BASIC.** The economic workplace system.



**Transfer systems.**



**FIFO shelves.** The flexible material feed.



**Deployment shelves.**



**Cupboard and shelf systems.**



**Measuring and testing technology.**

Ergonomics.  
**Functionality.**  
Custom design.



Andreas KARL GmbH & Co. KG | Hauptstraße 26 | 85777 Fahrenzhausen | Germany  
Fon: +49 8133 17-0 | Fax: +49 8133 17-11 | E-Mail: [sales@karl.eu](mailto:sales@karl.eu) | [www.karl.eu](http://www.karl.eu)